

# Blaze AHRS-2

# Blaze AHRS-4

# Blaze MAG-2

**AHRS-2:** Artificial Horizon and Magnetic Compass indicator

**AHRS-4:** Self Contained Artificial Horizon, Magnetic Compass indicator

**MAG-2:** Magnetic Compass Indicator

Operating Manual – English 1.05

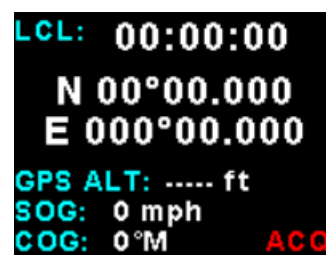
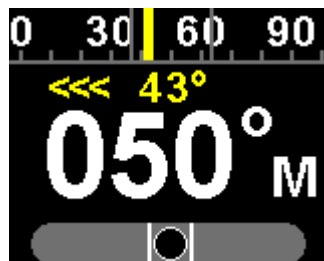

# Introduction

The AHRS-2 / AHRS-4 / MAG-2 is a 3 1/8" (80mm) sunlight readable color display instrument providing a display for an artificial horizon reference system (AHRS), an advanced digital compass, or both depending on which sensor packages is connected.

**The AHRS-2 is an attitude display for the external MGL-Avionics SP-7 attitude sensor package. The AHRS-2 requires the MGL-Avionics SP-6 compass sensor package to display heading.**

**The AHRS-4 is a self contained attitude display with built in sensors. The AHRS-4 does not require the MGL-Avionics SP-7 sensor package in order to display the attitude, but requires the MGL-Avionics SP-6 compass sensor package to display heading. The AHRS-4 can output CAN bus messages to emulate the MGL Avionics SP-7 sensor package.**

**The MAG-2 is a compass display for the external MGL-Avionics SP-6 compass sensor package.**

The AHRS-2 / AHRS-4 / MAG-2 can be setup to display the following:

- Compass with optional slip indicator (requires MGL Avionics SP-6 sensor package)
- Horizon with optional slip, turn indicator & G-Force (requires the MGL Avionics SP-7 if using the AHRS-2)
- Turn and bank indicator (requires the MGL Avionics SP-7 if using the AHRS-2)
- Combined compass and horizon display with bank indicator, optional slip indicator & G-Force (requires MGL Avionics SP6 & the Avionics SP-7 if using the AHRS-2)

# 1 Features

- Large 2.6" high resolution 320x240, IPS (fully viewable in all directions), sunlight readable color LCD display
- AHRS-2 (Artificial horizon reference system (AHRS) display unit with slip indication, turn and bank and G-Force indication), requires the MGL Avionics SP-7 sensor packages
- AHRS-4 (Artificial horizon reference system (AHRS) display unit with slip indication, turn and bank and G-Force indication) complete with built in attitude sensors. The AHRS-4 does not require the MGL Avionics SP-7 sensor package to display attitude.
- Advanced magnetic compass with a course steering feature and slip indication
- Can be setup as an individual compass display, artificial horizon or both
- The AHRS-2 / AHRS-4 / MAG-2 is connected to the AHRS / Compass sensor packages by a simple CAN bus interface. This allows for the optimum placement of the sensor packages in the aircraft
- More then one AHRS-2 / AHRS-4 / MAG-2 unit can be connected onto the CAN bus. This allows the compass, artificial horizon and the turn and bank indicator to be displayed on different units
- G-Force indicator (MGL Avionics SP-7 required if using the AHRS-2)
- Built in NMEA GPS Viewer
- Automatic or manual magnetic variation calculation
- Sunset and sunrise time display
- Displays time & date, GPS altitude, SOG, COG, latitude and longitude when using an external NMEA compatible GPS receiver
- Includes a RS232 serial output for interfacing to external equipment e.g dataloggers etc.
- The AHRS-4 can output CAN bus messages to emulate the MGL Avionics SP-7 sensor package.
- Standard 3 1/8" (80mm) aircraft enclosure (can be front or rear mounted)
- The LED backlight can automatically adjust to the ambient light, or it can be manually adjusted in the menu system
- Rotary control plus 2 independent buttons for easy menu navigation and user input
- An external output activates when a high alarm condition has been reached
- Wide input supply voltage range of 8 to 30V DC with built in voltage reversal and over voltage protection for harsh electrical environments
- 1 year limited warranty

## 2 Layout

### 2.1 AHRS-2 / AHRS-4 Layout

**Ambient light sensor**

3 1/8" (80mm) enclosure. Can be front or rear mounted

**Sunlight readable color graphic display:**  
The backlight can automatically adjust to the ambient light or it can be manually adjusted in the menu system

**F1 / Up Button:**  
Menu System: Softkey button  
Pitch level function

**F2 / Down Button:**  
Menu System: Softkey button  
Fast level function

**Rotary Control (Up/Down) & Enter Button:**  
Press the rotary control during the normal display screens to access the menu system. Rotate anti/clockwise for up/down menu scrolling. During normal mode turning the rotary control anti/clockwise will scroll through the main displays (Artificial horizon, compass and turn and bank indicator).

### 2.2 MAG-2 Layout

**Ambient light sensor**

3 1/8" (80mm) enclosure. Can be front or rear mounted

**Sunlight readable color graphic display:**  
The backlight can automatically adjust to the ambient light or it can be manually adjusted in the menu system

**F1 / Up Button:**  
Menu System: Softkey button  
Enable coarse steering display

**F2 / Down Button:**  
Menu System: Softkey button  
Enable the reverse coarse display

**Rotary Control (Up/Down) & Enter Button:**  
Press the rotary control during the normal display screens to access the menu system. Rotate anti/clockwise for up/down menu scrolling.

### 3 Main Displays

The AHRS-2/4 can be set up to show 5 different display screens. Turning the rotary control either clockwise or anti-clockwise allows you to select the operation of the AHRS-2 / AHRS-4 as an artificial horizon with mini compass and turn and bank indicator, a turn and bank indicator, a digital compass, or as a NMEA GPS viewer

The MAG-2 only displays the compass and GPS displays.

**Note:** If you have purchased the artificial horizon and compass sensor packages with two or three AHRS-2 / AHRS-4 / MAG-2 displays, it is possible to setup either of the units to display either the artificial horizon, turn and bank indicator or the compass.

#### 3.1 Artificial Horizon with Compass

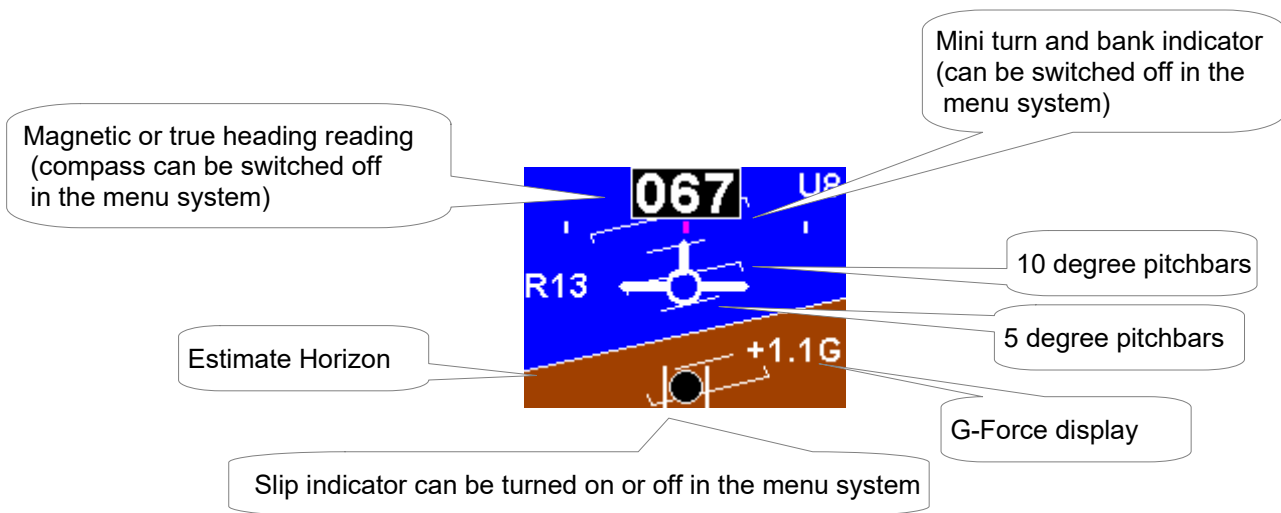

#### Pitch level function

Should your aircraft fly “nose up” or “nose down” due to trim, then you can press the F1 key to level the pitch as displayed on the horizon.

#### 3.2 Turn and Bank Indicator



#### Slip indicator

A “step on the ball” slip indicator can be enabled to appear below the horizon and compass displays. The source of information for this indicator is derived from the accelerometer aligned with the pitch axis of the aircraft, i.e. the acceleration forces acting in the direction of the wings.

**Fast level function**

Press the F2 key should the horizon display be toppled (i.e. indicating incorrectly by a large amount) due to excessive maneuvering or by exceeding the maximum bank, pitch or yaw rates. This will indicate to the instrument that you are flying straight and level and that gravity tracking may be accelerated to ensure rapid realignment of the horizon.

**Extended range of operation**

Please see the corresponding MGL sensor documentation for maximum rate specifications.

Depending on conditions maximum rates may reach 180 degrees per second. No caging of the electronic gyro system is required during excessive maneuvering, unlike systems based on mechanical gyros. Simply correct the horizon when you are finished or let the horizon right itself which will happen during straight and level flight.



Message displayed when the maximum bank, pitch or yaw rates have been exceeded

**3.3 Digital Compass**

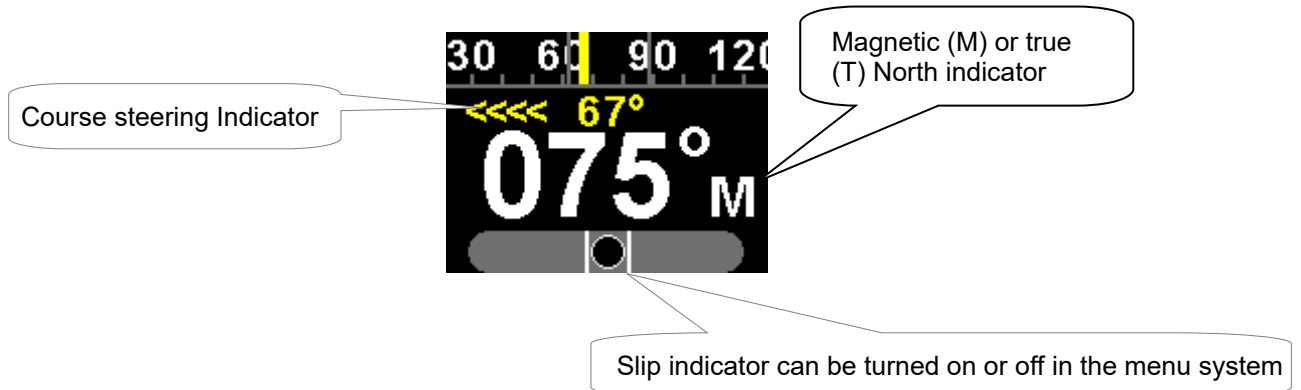

**3.3.1 Compass Tape**

The digital compass tape can be displayed in 3 different ways. The way the compass is displayed can be setup in the menu system under "COMPASS SETUP"



**Numeric compass display**

The heading tape shows headings as numbers in degrees.



**Mixed compass display**

The heading tape shows headings as number in degrees except for the four major cardinal points which are shown as N, S, E and W.



**Cardinal compass display**

The heading tape shows headings as major and intermediate cardinal points: N, NE, E, SE, S, SW, W and NW.

### 3.3.2 Heading bug and the course steering indication

To activate the heading bug, press the F1 key when the compass display is showing.



Press the F1 key again to use the current heading as the heading bug or use the rotary control to manually enter a heading. Press the F2 key if you want to switch the heading bug off.



The heading bug set to 176 degrees. Currently the heading equals the course to steer as shown below the heading tape. No course steering indicators are shown.



The current heading is 169 degrees; course steering indicators show the need to steer slightly to the right to intercept the course.



The current heading is 218 degrees; course steering indicators show that a large correction to the left is required to intercept the course.

Each ">" or "<" equals 2 degrees of heading error. To cancel the course steering function, simply press the F1 key again.

### 3.3.3 The reverse course (from heading) display



Press the F2 key to activate the reverse course display. This display remains active for about 5 seconds before reverting back to the normal heading display.

### 3.3.4 Heading stability issues

You may find short term fluctuations of the heading occurring. These tend to be very small and are typically less than one degree. This could still cause the heading to fluctuate occasionally by a single degree. These fluctuations occur naturally in the earth's magnetic field and can also be caused by nearby electrical equipment such as radios, lamps, electronic instrumentation or computers, even the ignition systems of engines. The AHRS-2 / MAG-2 has a compass filter setting which can be set to filter out some of these small fluctuations.

## 3.4 GPS Viewer

```
UTC: 00:00:00
      0 JAN 0
N 00°00.000
E 000°00.000
MAG VAR (M): 0° E
SUNRISE: 05:40
SUNSET: 17:47 ACQ
```

```
LCL: 00:00:00
      N 00°00.000
      E 000°00.000
GPS ALT: ..... ft
SOG: 0 mph
COG: 0°M ACQ
```

These displays are active when a NMEA compatible GPS receiver is connected to the serial port.

The following GPS information is displayed:

- Time and date
- Latitude and Longitude
- Magnetic variation
- Sunrise and Sunset times
- GPS altitude
- SOG (Speed over ground)
- COG (course over ground)
- GPS fix

## 4 Menu System

Press the rotary control button during the normal display mode to enter the menu system. Use the rotary control to navigate through the menu system.

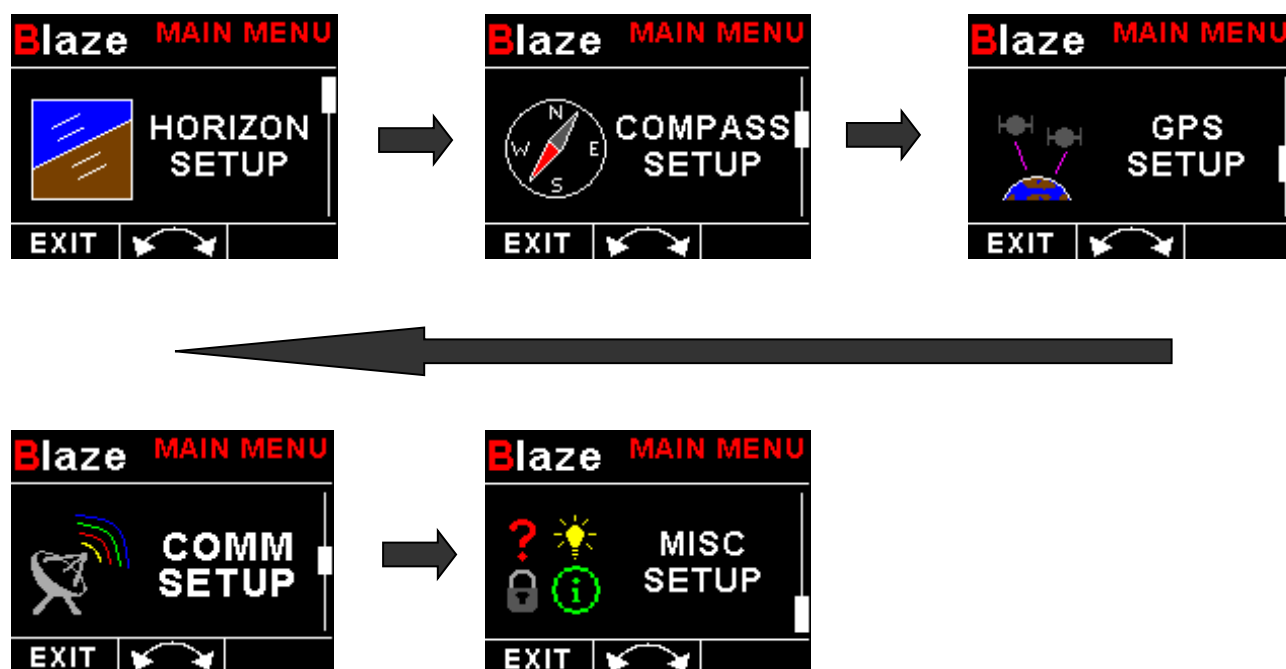

### 4.1 Exiting the menu system

Press the F1/Up button to exit the menu system when the "EXIT" soft key is shown. All changes made during navigation of the menu system will be saved in non-volatile memory upon exiting. The instrument will not save any changes if you remove power before exiting the menu system.



## 4.2 Horizon Setup

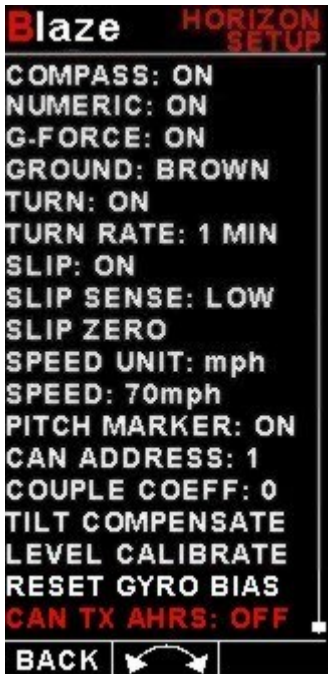

### **Compass:**

Select "ON" if you would like to see the compass box on the horizon display.

### **Numeric:**

Select "ON" if you would like to see a numeric display of bank and pitch angles superimposed on the horizon display.

### **G-Force:**

Select "ON" if you would like to see the G-Force displayed on the horizon display.

### **Ground :**

Select the ground color of the horizon. A selection between "BROWN" (default) or "GREEN" can be made.

### **Turn:**

Select whether you want the turn indicator to be shown on the horizon display screen.

### **Turn Rate:**

Select whether you want the turn and bank indicators to show a 1 min/rotation or 2 min/rotation turn.

### **Slip:**

Select if you would like to enable the slip indicator to be shown underneath the horizon display. The slip indicator operates in the same fashion as the well known "step on the ball" indicator in traditional cockpits.

**Note:** The slip indicator is always enabled in the turn and bank indicator mode.

**Slip Sense:**

Select if you want the slip to have a high sensitivity or a low sensitivity setting.

**Slip Zero:**

This function allows you to set your slip indicator to exactly zero even if your aircraft tends to fly slightly wing down. The procedure is to place the aircraft in a stable, straight and level attitude during calm flight conditions and then select this function. To cancel the correction, place your sensor absolutely horizontal (use a spirit level) and select the function again.

**Speed Unit:**

Select the speed unit.

**Speed:**

Enter the cruising speed of your aircraft. This speed is transmitted to the attitude sensor for aiding purposes if the GPS speed is not available.

**Pitch Marker:**

This enables or disables the pitch markers on the horizon display.

**CAN Address:**

Select the CAN address of the SP-X attitude sensor.

**Couple Coeff (AHRS-4 only):**

This is a number from 1 to 10. "1" is the default.

This number determines how "strongly" the AHRS will force the gyro derived horizon estimate to coincide with that of the accelerometer based level calculations which are based on gravity.

"1" causes a very slow correction. This is the normal state and used most often.

"10" is the highest correction speed. This is usually used if the AHRS is used in unfavorable conditions.

**Background:**

Gyros can only tell you if you are rotating around any axis (you have three of them). Gyros cannot tell your attitude, they can only tell you how your attitude is changing.

Accelerometers can tell you your attitude – but only if you are not accelerating. That includes a turn as this involves acceleration (constant change of direction). In addition accelerometers will react to any movement of your aircraft caused by turbulence etc.

So – basically accelerometers can sometimes tell you your attitude while gyros can tell you how your attitude has changed – but with errors as measurements are never 100% accurate – so the longer you rely only on the gyros the worse it gets.

To a large extent the AHRS can estimate accelerations acting on your aircraft as it knows the aircraft's velocity. This means it can estimate a reasonably valid attitude from the accelerometers that is "noisy" even in accelerated flight. For this to be possible it has to assume how your aircraft moves through space. So it is mostly correct but sometimes not.

The coupling coefficient allows you to trade between the two.

Usually a panel mounted AHRS is affected by vibrations from engines (gyros don't like vibrations). This is the largest error source for a typical AHRS. If your installation suffers from that a higher coupling number may assist as gyro errors are larger than normal.

If this does not help you will have to either try and reduce vibrations affecting the panel or install an external AHRS like the SP-7 or high grade SP-9. This allows locating the AHRS in a more suitable and protected area. If the AHRS-4 detects an external AHRS it will automatically use it. External AHRS is connected onto the CAN bus.

***Tilt Compensate (AHRS-4 only):***

This allows installation of the AHRS-4 at angles other than vertical (face). Select this menu item once installation of the AHRS-4 indicator is complete. The tilt compensation only needs to be performed once. This allows to set a pitch tilt of the AHRS, keeping all speed related items affecting the accelerometers aligned correctly.

***Level Calibrate (AHRS-4 only):***

This function can be used to level the AHRS. It levels bank and pitch and sets the Z axis (up down) to 1G.

The level calibrate function here MUST be performed with the AHRS perfectly level, i.e. display in normal orientation at 90 degrees from the horizontal in both pitch and bank. This function “tweaks” the accelerometer sensor using the Earths gravity as a reference.

This function takes around 10 seconds to execute. Keep the AHRS perfectly still until completed.

Note: The AHRS will refuse to perform this operation if real AHRS bank or pitch angle is greater than 10 degrees.

***Reset Gyro Bias (AHRS-4 only):***

Your AHRS gyros bias point is the point where your gyros report that you are not rotating around any axis. Gyro bias may drift over time as the gyro chip ages. This function resets the bias to the current reading and is performed with the aircraft on the ground, preferably in a hangar with no wind rocking the aircraft. The aircraft may be in any attitude but must remain perfectly still during this procedure. After you activate this procedure it takes about 30 seconds to complete it. Keep the aircraft perfectly still during this operation.

***CAN TX AHRS (AHRS-4 only):***

Select “ON” to output the MGL Avionics SP-7 CAN bus messages. This gives the AHRS-4 the ability to emulate the MGL Avionics SP-7 sensor package.

## 4.3 Compass Setup



### **Display:**

Select the style of the compass tape as in section display mode as described in section 3.3 above

### **Heading:**

Select whether you would like the instrument to display magnetic or true heading. If you select true heading, you need to enter the correct magnetic variation for your location. You can find your local variation on aeronautical or maritime charts. The heading displays will be augmented with °M or °T depending on the mode you have selected.

### **Mag Var:**

Select manual or automatic magnetic variation. Automatic variation is only possible if using an external NMEA compatible GPS receiver.

### **Variation:**

Enter the magnetic variation of your location. This is only used if you would like the instrument to display true heading. True heading is the heading relative to the geographic North Pole. Magnetic heading is the heading relative to the magnetic North Pole. Variation is expressed in degrees east or west. Please note that should you move a long distance, you may have to update the variation setting. This setting may be ignored if you only use the magnetic heading display option.

### **Filter:**

Select the filter factor for the compass heading. A selection of "NONE", "LOW", "MED" or "HIGH" can be made. This can improve the stability of the compass.

### **Slip:**

Select if you would like to enable the slip indicator to be shown underneath the horizon display. The slip indicator operates in the same fashion as the well known "step on the ball" indicator in traditional cockpits.

### **Slip Sense:**

Select if you want the slip to have a high sensitivity or a low sensitivity setting.

**Slip Zero:**

This function allows you to set your slip indicator to exactly zero even if your aircraft tends to fly slightly wing down. The procedure is to place the aircraft in a stable, straight and level attitude during calm flight conditions and then select this function. To cancel the correction, place your sensor absolutely horizontal (use a spirit level) and select the function again.

**Can Address:**

Select the CAN address of the SP-X compass sensor.

**Calibrate**

This allows calibration of the magnetic sensor.

**In-Flight calibration Procedure**

Please see documentation supplied with the SP-6 for more information.

Fly the aircraft in safe area where you can perform random banked turns. Do not exceed the safety limits of the aircraft during the calibration flight.

Start the calibration in the Compass setup menu by selecting "Calibrate". The AHRS-2 / AHRS-4 / MAG-2 will display the compass calibration screen. You should see the compass heading change to "111" to confirm that calibration has started.

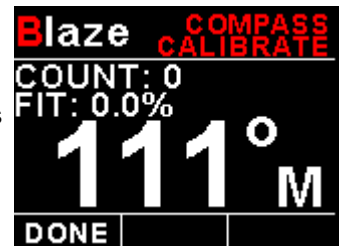

Fly a number of banked 180 or 360 degree turns at different bank angles - i.e. shallow, medium and steep turns. Try to add many different pitch attitudes in various orientations relative to the field direction. It does not matter in what order you fly the maneuvers. A typical, good calibration tends to take 5-10 minutes of flight.

Do not activate any electrical equipment that creates large magnetic fields during the calibration process (for example starter motors, autopilot servos, landing lights etc). The heading starts reading **111** after you start calibration. After 36 initial samples have been collected this changes to **222**. This should take approximately one turn. Continue the flight while maneuvering until the heading starts reading normally. This happens once the SP-6 has collected 100 distinctly different magnetic samples. At this point the heading should start showing reasonable numbers. Continue the calibration flight, settling into straight and level at intervals on different headings and verify the heading readout against an ACCURATE reference. Continue the flight until you find heading errors that are within 1 to 2 degrees, about the limit one can reasonably expect.

When satisfied, end the calibration by selecting "DONE" in the compass calibration menu. This will save the calibration to permanent memory in the SP-6. Should you not be able to achieve a good heading readout, please locate the compass to a better location in the aircraft.

The AHRS-2 / MAG-2 displays the calibration sample count and fit percentage during calibration. The sample count will count up to 150 after which new samples replace the oldest samples stored. The fit percentage is a value from 0% to 100%. The aim is to get to a value as close as possible to 100%. The fit starts displaying other than 0% after the first 36 samples. Fit values of 98% and higher are considered good. If you cannot achieve this you do not have a good installation location for your compass. You may still get reasonably good heading accuracy despite a lower fit. However, to ensure long term accuracy please consider locating the SP-6 in a better area in your aircraft.

If the readout decreases suddenly by a large amount (for example from 85% to 42%), this is typically caused by a strong time-variant magnetic field such as can be created by electrical equipment (motors, relays, current flow in cables). In such a case please either end and restart the calibration or continue the calibration flight until the fit error is acceptable again (the incorrect magnetic sample(s) will eventually be removed). It is advised to locate the interference source and either move this or the SP-6 to a better location in the aircraft.

Note: should you move the SP-6 to a new location or fit new equipment close to the SP-6 you will have to perform the calibration again. There is no practical limit as to how many times you can perform and save a new calibration.

## 4.4 GPS Setup



### **GPS Display:**

Select to enable or disable the GPS display.

### **NMEA Baud:**

Select the baud rate of the externally connected GPS receiver.

### **Position:**

Select the display format of the GPS latitude and longitude.

### **Altitude Unit:**

Select if you want the GPS altitude displayed in ft (feet) or m (meters).

### **COG:**

Select if you want coarse over ground displayed as magnetic or true.

### **Speed Unit:**

Select if you want the speed over ground to be displayed in mph (statute miles per hour), km/h (kilometers per hour) or knots (nautical miles per hour).

### **UTC Offset:**

Enter the UTC offset for your location. The UTC offset can be adjusted in half an hour increments.

### **Mag Var:**

Select manual or automatic magnetic variation. Automatic variation is only possible if using an external NMEA compatible GPS receiver.

### **Variation:**

Enter the magnetic variation of your location. This is only used if you would like the instrument to display true heading. True heading is the heading relative to the geographic North Pole. Magnetic heading is the heading relative to the magnetic North Pole. Variation is expressed in degrees east or west. Please note that should you move a long distance, you may have to update the variation setting. This setting may be ignored if you only use the magnetic heading display option.

## 4.5 COMM Setup (Communication Setup)



### **Serial Out:**

Select "ON" to enable the RS232 serial output.

### **Unit Address:**

Enter the unit address.

### **Baud Rate:**

Select the desired baud rate of the serial output.

## 4.5.1 Protocol Format

### **STX, Address, Message type, Length, Data payload, Checksum, ETX**

STX: Start of text (0x02)

Address: unsigned char (8bit), Unit address (range 0-255)

Message Type: unsigned char (8bit), Specifies the message type

Length: unsigned char (8bit), Length of the data payload (does not include the STX, Address, message type, checksum or ETX)

Data payload: Data

Checksum: unsigned char (8bit), XOR of all bytes starting from the unit address to the end of the data payload. The checksum is seeded with 0xa5. (does not include the STX or ETX)

ETX: End of text (0x03)

## 4.5.2 Data payload

Message type=12

Data Length=12 bytes

Output Rate=10Hz

Bank Angle:	Signed Int (16 bits), Bank Angle in 0.1 degrees
Pitch angle:	Signed Int (16 bits), Pitch Angle in 0.1 degrees
Yaw Angle:	Signed Int (16 bits), Yaw Angle in 0.1 degrees
Slip:	Signed char (8 bits), Slip left/right 0=0x80
Attitude Status:	Unsigned char (8 bits), bit 2 set = AHRS overrange
Heading:	Unsigned Int (16 bits), Heading in 0.1 degrees
G-Force:	Signed Int (16 bit), G-Force in 0.1G



### 4.6 MISC Setup (Miscellaneous Setup)

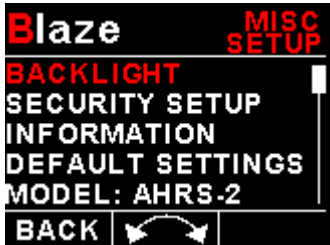

**Backlight:**



Select manual or automatic backlight control.

Use the rotary control in manual mode to adjust the backlight brightness.



Allow 3 seconds for the display to adjust to the ambient lighting conditions when using the automatic backlight mode. The display will set the backlight to the dim setting if the ambient light is less than the threshold setting, alternatively the display will set the backlight to the bright setting if the ambient light is greater than the threshold setting. The ambient light received is shown as the ADC value in the top header. Use this value to set the threshold value.

**Security Setup:**

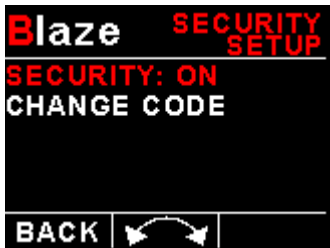

Select this menu option if you want to password protect the menu system.



**Information:**

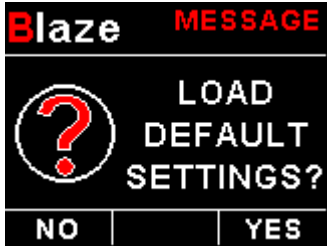

This menu option displays information about the unit.

**Default Settings:**

Select this menu option to reset all the settings to factory defaults.

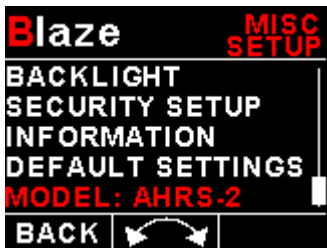
**Model:**

This menu option is used to select which model of display you have. Select MAG-2 if you only want a compass display as then all menus pertaining to the AHRS-2 will be hidden.

## 5 Using the AHRS-2 / AHR-4 / MAG-2 and SP-X sensor packages in flight

The pilot in command of the aircraft has to be aware of the following:

The AHRS-4 and SP-X sensor packages are not certified by the FAA or any other agency for use during IFR (instrument flight rules). This implies that any such flight that uses the AHRS-4 / SP-X sensor packages as reference for either heading, turn and bank or horizon is illegal.

## 6 RS232 NMEA enabled GPS receiver message

The AHRS-2 / AHRS-4 and MAG-2 have the ability to be connected to a NMEA enabled RS232 GPS receiver to allow the AHRS-2 to use the actual ground speed in the attitude aiding algorithms.

The NMEA enabled RS232 GPS receiver must be able to output a GPRMC message (The Recommended Minimum sentence defined by NMEA for GPS/Transit system data.) This message is defined as:

```
$GPRMC,hhmmss,status,latitude,N,longitude,E,spd,cog,ddmmyy,mv,mvE,mode*cs<CR><LF>
```

**Example:** \$GPRMC,083559.00,A,4717.11437,N,00833.91522,E,0.004,77.52,091202,,A\*57

## 7 Loading factory default settings



Press and hold the F1/Up button and rotary control during power up to load the pre-programmed factory default settings. The following screen will be displayed:

Factory default settings can also be loaded in the Miscellaneous setup menu.

## 8 Error Messages



Unit settings CRC error. Load default settings to restore to factory defaults. If the error message still persists then it could possibly be a non-volatile memory failure in which case the instrument will then have to be returned to the factory.



Internal flash CRC error. The instrument does a firmware check on the program when power is applied to the instrument. If the program is corrupt in any way then the internal flash CRC error will be displayed. Reload the instruments firmware and load default settings. If the error message still persists then it could possibly be an internal flash memory failure in which case the instrument will then have to be returned to the factory.

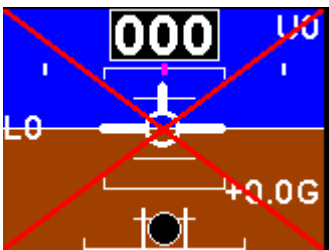

The display will have a red cross over the indicators to signal a SP-X sensor communication or sensor failure. Check the communication link between the AHRS-2 / MAG-2 and the SP-X sensors and that the SP-X sensors themselves are functional.

## 9 Specifications

Operating Temperature Range	-10°C to 60°C (14°F to 140°F)
Storage Temperature Range	-20°C to 80°C (-4°F to 176°F)
Humidity	<85% non-condensing
Power Supply	8 to 30Vdc SMPS (switch mode power supply) with built in 33V over voltage and reverse voltage protection
Current Consumption	Approx. 130mA @ 12V (backlight highest setting), 50mA @12V (backlight lowest setting)
Display	2.6" 320x240 IPS color LCD display Minimum 600cd/m2 brightness Sunlight readable with anti-glare coating LED Backlight can be set to automatic or can be manually adjusted
Alarm Output	Open collector transistor switch to ground Maximum rating 0.25A
Dimensions	see Blaze series dimensional drawing
Enclosure	3 1/8" (80mm) ABS, black in color, front or rear mounting. Flame retardant.
Weight	Approx. 150 grams (Instrument excluding cables)
Non-volatile memory storage	100000 write cycles
NMEA Supported Message	GPRMC (Recommended Minimum Sentence) GPGGA (Global Positioning System Fix Data) GPGSA (GPS DOP and active satellites) GPGSV (GPS Satellites in view)
NMEA Supported Baud rate	1200 to 115200

## 10 Operating the alarms

The alarm output can be used to switch an external alarm indicator. The external alarm switch is an open collector transistor switch to ground with a maximum rating of 0.25A DC. It is possible to wire the alarm contacts of several Stratomaster instruments in parallel should this be desired. To avoid false activation of the alarms, the alarm function is only active 10 seconds after the instrument has powered up.

## 11 Firmware Upgrading

The AHRS-2 / AHRS-4 / MAG-2 can be upgraded in the field by connecting the RS232 port to a PC and running the firmware update program. **Note that only the RS232 port can be used to upgrade the firmware.**

Please see the Blaze firmware upgrading document for more information.

## 12 Installation

### AHRS-4

The Tilt Compensate function must be done after the installation of the AHRS-4 has been completed. This allows installation of the AHRS-4 at angles other than vertical (face). The tilt compensation only needs to be performed once.

**Note:** Please see corresponding SP-X sensor package manuals for more information about the installation and use of the artificial horizon and compass.

### 12.1 Cable connections

Main connector (D15HD connector: Unit Female, Cable Male)

D15HD Pin	Color	Function
1	Red	8-30Vdc power via power switch / circuit breaker and fuse.
2	Black	Ground
3	-	RS232 Transmit data (Firmware upgrading)
4	White/Black Stripe	RS232 Receive data (Firmware upgrading / NMEA GPS Input)
12	Purple	CAN Low
13	Pink	CAN High
15	White	Alarm Output (Open collector)

### 12.2 Connection Diagram

The use of an external 1A fuse is recommended. Connect the supply terminals to your aircrafts power supply. Ensure that the supply voltage will not drop below 8V during operation as this may result in incorrect readings.

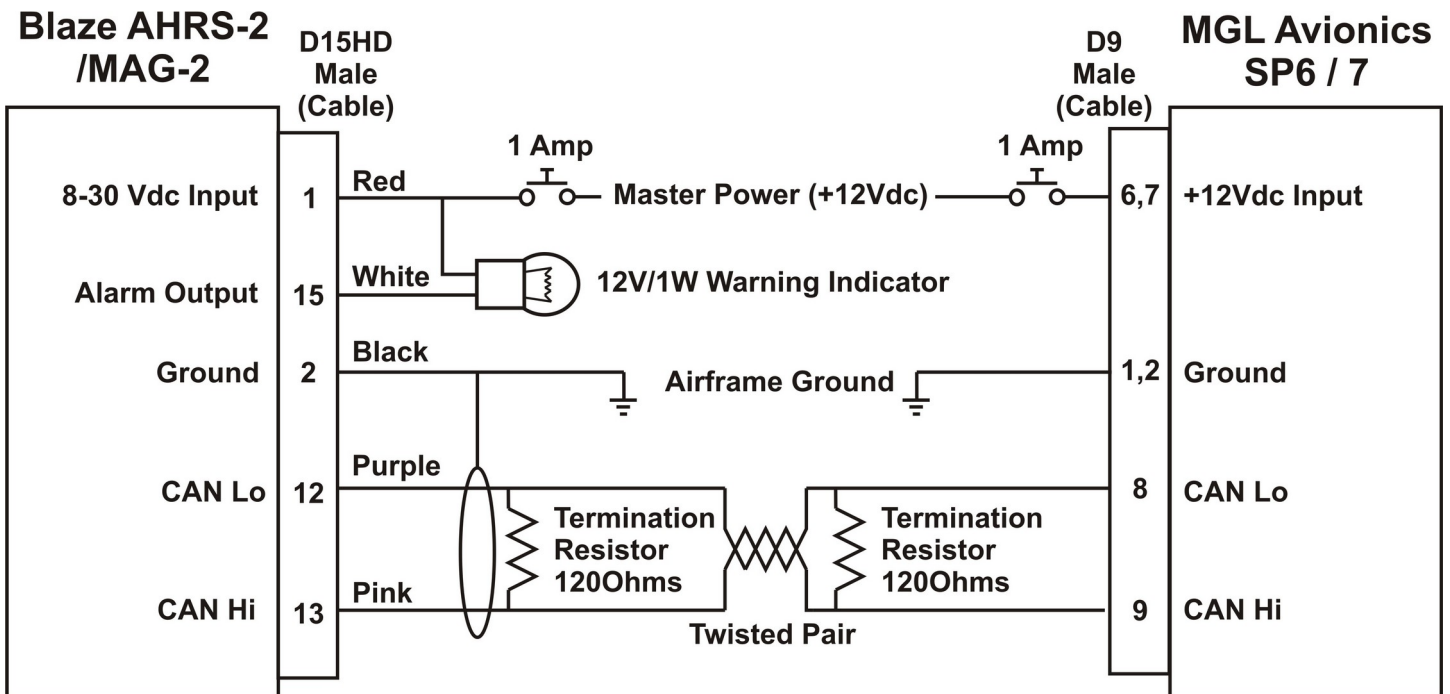

# 13 Dimensions

## Stratomaster Blaze 3.125" (80mm) Dimensions

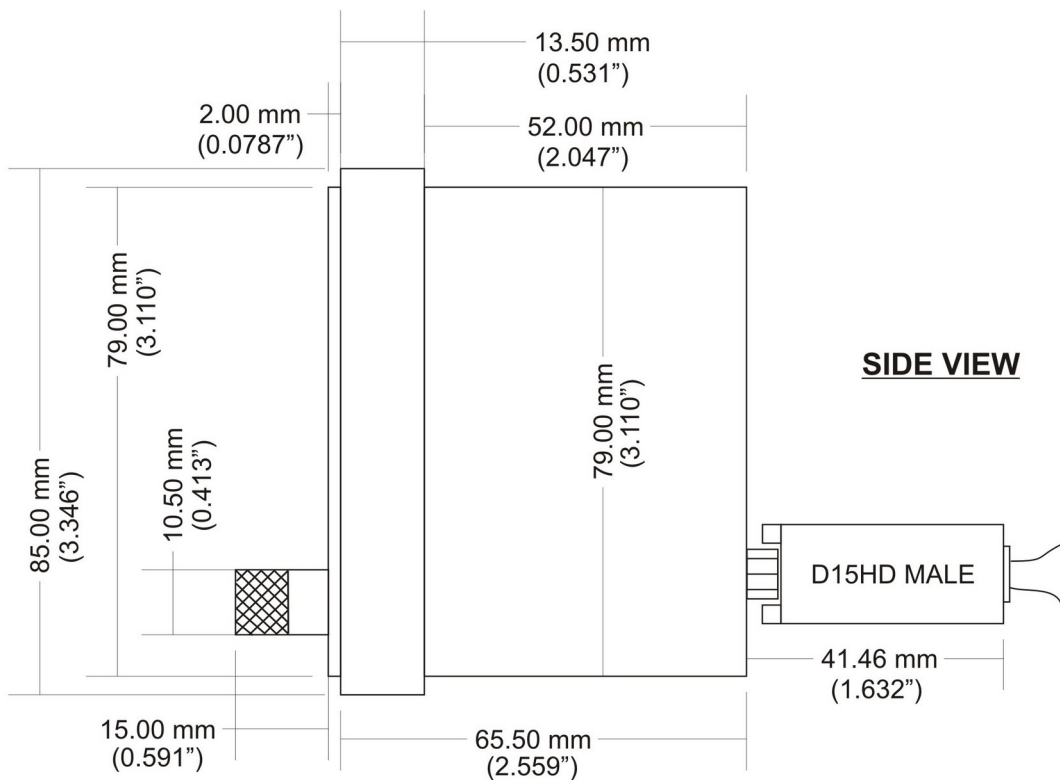
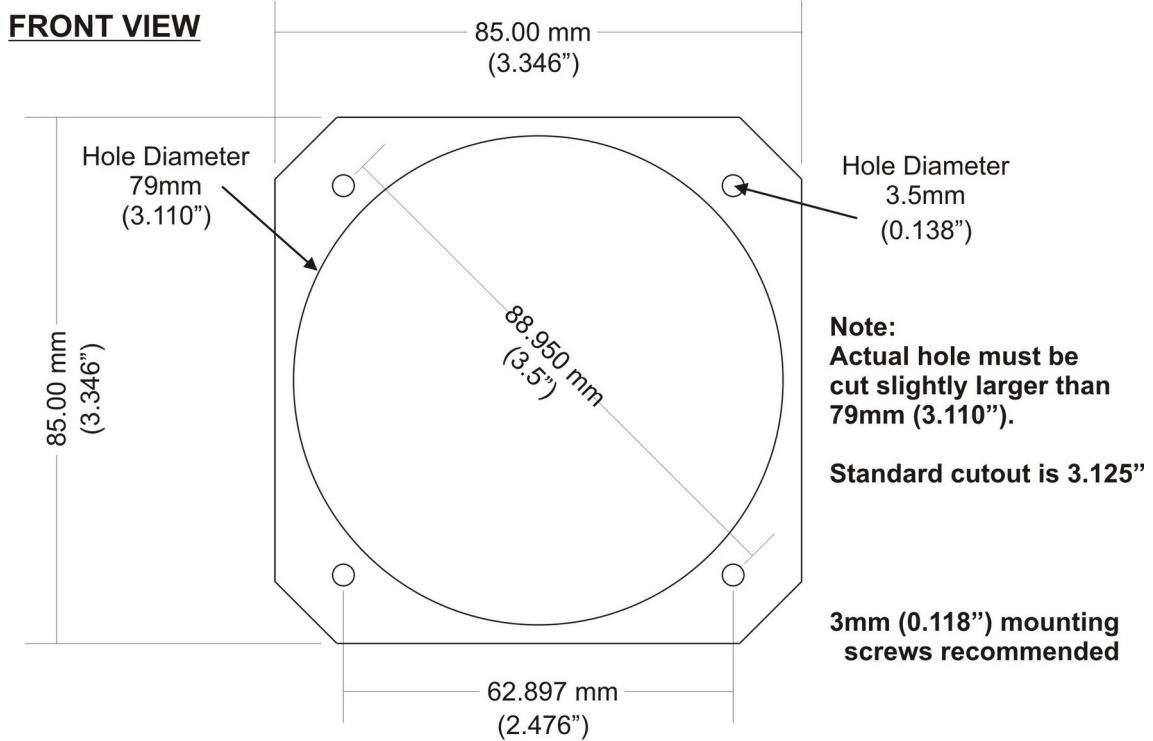

## 14 Cleaning

The unit should not be cleaned with any abrasive substances. The screen is very sensitive to certain cleaning materials and should only be cleaned using a clean, damp cloth.

**Warning:** The AHRS-2 / AHRS-4 / MAG-2 is not waterproof, serious damage could occur if the unit is exposed to water and/or spray jets.

## 15 Warranty

This product carries a warranty for a period of one year from date of purchase against faulty workmanship or defective materials, provided there is no evidence that the unit has been mishandled or misused. Warranty is limited to the replacement of faulty components and includes the cost of labor. Shipping costs are for the account of the purchaser.

**Note:** Product warranty excludes damages caused by unprotected, unsuitable or incorrectly wired electrical supplies and or sensors, and damage caused by inductive loads.

## 16 Disclaimer

Operation of this instrument is the sole responsibility of the purchaser of the unit. The user must make themselves familiar with the operation of this instrument and the effect of any possible failure or malfunction.

This instrument is not certified by the FAA. Fitting of this instrument to certified aircraft is subject to the rules and conditions pertaining to such in your country. Please check with your local aviation authorities if in doubt. This instrument is intended for ultralight, microlight, home built and experimental aircraft. Operation of this instrument is the sole responsibility of the pilot in command (PIC) of the aircraft. This person must be proficient and carry a valid and relevant pilot's license. This person has to make themselves familiar with the operation of this instrument and the effect of any possible failure or malfunction. Under no circumstances does the manufacturer condone usage of this instrument for IFR flights.

### **IMPORTANT NOTICE:**

You must make your own determination if the products sold by MGL Avionics are safe and effective for your intended applications. MGL Avionics makes no representations or warranties as to either the suitability of any of the products we sell as to your particular application or the compatibility of any of the products we sell with other products you may buy from us or anywhere else, and we disclaim any warranties or representations that may otherwise arise by law. Also, we offer no specific advice on how to install any of the products we sell other than passing along anything that may have been provided to us by the manufacturer or other issues. If you are in need of further information or guidance, please turn to the manufacturer, FAA Advisory Circulars and guidance materials, the Experimental Aircraft Association, or other reputable sources.

**Continuing development sometimes necessitates specification changes without notice.**

## Other instruments in the *Stratomaster Blaze* series

<b>AHRS-2</b>	Artificial Horizon and Magnetic Compass Indicator
<b>AHRS-4</b>	Self contained Artificial Horizon and Magnetic Compass Indicator
<b>ALT-6</b>	Altimeter and Vertical Speed Indicator (VSI)
<b>ALT-7</b>	Altimeter and Vertical Speed Indicator (VSI) with a transponder compatible RS232 & parallel Gillham code output
<b>ASI-5</b>	Airspeed Indicator (ASI)
<b>ASV-2</b>	Altimeter, Airspeed (ASI) and Vertical Speed Indicator (VSI)
<b>EMS-2</b>	Engine Monitoring System
<b>FF-5</b>	Fuel Computer
<b>FLIGHT-3</b>	Primary Flight Instrument
<b>INFO-2</b>	Information Display (G-Force meter, UTC and Local Time, Slip Indicator, Outside Air Temperature (OAT), Battery Voltage, Current and charge display, Flight Timer & Flight Log, Stopwatch, Countdown Timer and Alarm)
<b>MAG-2</b>	Magnetic Compass Indicator
<b>MAP-4</b>	Manifold Pressure and RPM Indicator
<b>RPM-2</b>	Universal Engine / Rotor RPM Indicator
<b>TC-5</b>	4 Channel Thermocouple (EGT/CHT) Indicator
<b>TC-6</b>	12 Channel Thermocouple (EGT/CHT) Indicator
<b>TP-4</b>	4 Channel Universal Analog Input (Pressure/Temperature/Current/Volts) Indicator